

D

C

B

A

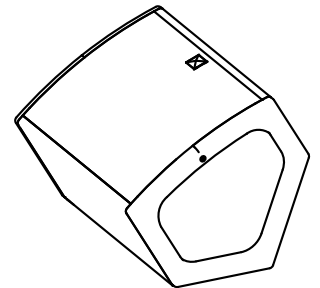
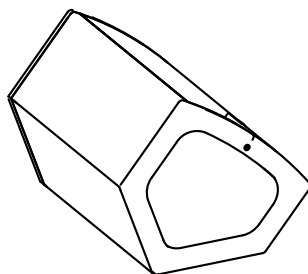
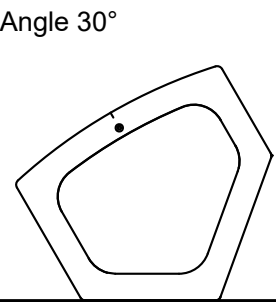
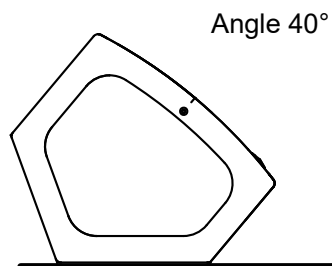
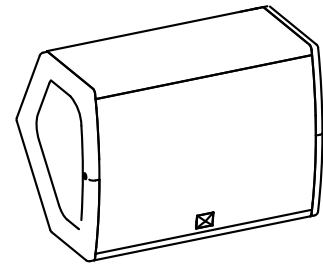
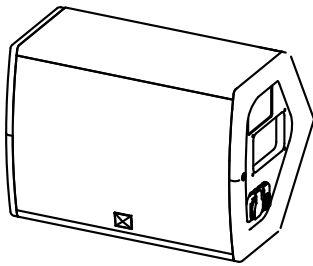
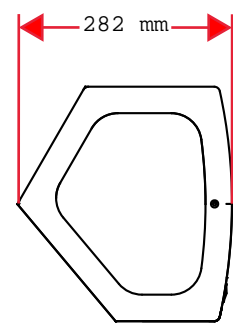
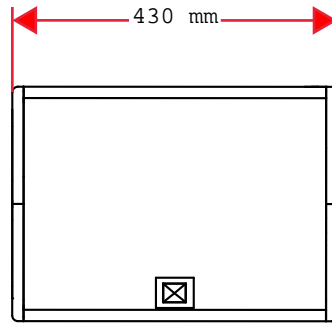
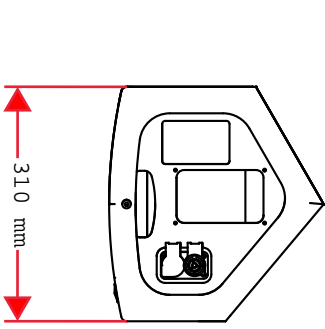

4

4

3

2

1

1

ÉCHELLE 1:10	W8A & W8	AUTEUR JN	
 A4		DATE 27/04/2018	
EMISON Acoustique		00	

D

C

B

A